

Thanks for buying the Jalo smoke alarm. Read all instructions before installing the smoke alarm, so it will protect your home in the best possible way.

- If you are installing the smoke alarm for some other person, leave these instructions or a copy of them with him/her.
- The Jalo smoke alarm is also suitable for use in a travel vehicle, such as camper vans, caravans, and boats.

1. POSITIONING THE SMOKE ALARM

- Place at least one smoke alarm per 60 m² on each floor.
- Place a smoke alarm in each corridor and bedroom.
- The smoke alarm is to be placed on the ceiling in such a way that it is in the middle of the room.
- Place a smoke alarm at the top of each staircase.

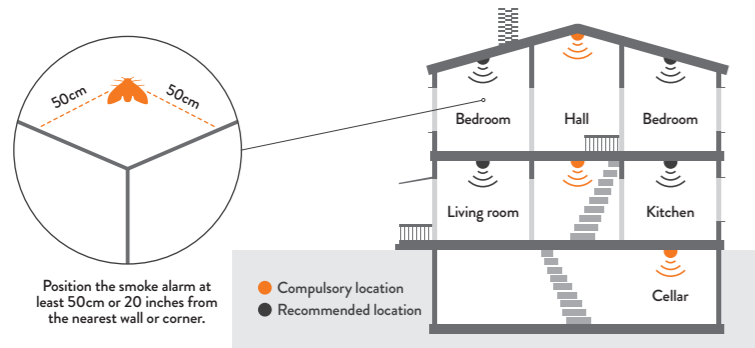

AVOID THESE POSITIONS:

Near a wall or corner: Place the smoke alarm at a distance of at least 50 cm from a wall or corner.

Moist places: Avoid installing smoke alarms near moist or occasionally moist places such as immediately close to a shower or kitchen, where steam can cause false alarms.

Ventilation ducts: Avoid installing a smoke alarm immediately next to a ventilation duct. The draft may prevent smoke from reaching the smoke alarm.

Dead-air spaces: Avoid installing a smoke alarm in the angle of a pitched roof. Install it at a distance of least 10 cm from the ridge.

Fluorescent lamps: Avoid installing a smoke alarm immediately next to fluorescent lamps, such as halogen lights.

2. INSTALLATIONS

A smoke alarm can be installed in two different ways: (1) Fast installation with two-sided tape or (2) by installing the smoke alarm with screws.

Note: Installation with 3M two-sided tape is not approved according to Great Britain's LPCB standard.

3. OPERATION AND TESTING

Alarm mode: When the smoke alarm detects smoke, it goes into an alarm mode in which the smoke alarm beeps continually.

Testing: Press the surface of the smoke alarm for three (3) seconds, until you hear the alarm sound. The entire surface works as a test button. Note that after testing, the smoke alarm goes into a silence mode.

Silence mode: By pressing the entire surface for (3) seconds, the smoke alarm goes into a silence mode. The silence mode lasts about 8 minutes. If smoke is extremely dense, the smoke alarm sounds in spite of being in a silence mode.

Low battery: The smoke alarm emits beep at intervals of about 30 seconds and the signal light flashes at the same time as a beep. Replace the batteries with new ones as soon as possible according to the guidelines in point 4, MAINTENANCE.

Error mode: The smoke alarm emits short beeps at intervals of about 30 seconds and the signal light flashes at different times. Remove the batteries and vacuum it carefully from its back part (see diagram 2.7 on the adjacent page). Put the batteries in and test again. If the smoke alarm is still in an error mode, contact the importer or manufacturer.

The serial number of the smoke alarm is found on the installation plate next to the battery hole.

If the smoke alarm goes out of order, contact the importer or the manufacturer.

4. MAINTENANCE

Battery life: The smoke alarm contains three (3) 3V lithium batteries (IEC-CR2450). Their lifetime is five (5) years. When the batteries are used up, the smoke alarm beeps at intervals of 30 seconds for at least 30 days. If the batteries are used up, replace them as soon as possible.

Recommended battery brands:

- MALAK CR2450 Lithium Cell 3V
- ENERGIZER CR2450 Lithium Cell 3V
- EVE CR2450 Lithium Cell 3V
- DURACELL CR2450 Lithium Cell 3V

Battery replacement: Remove the top battery lightly with the fingers. Remove the rest of the batteries by turning the smoke alarm upside down and shaking it lightly. Install all batteries with the minus pole toward the bottom of the battery chamber. Test the smoke alarm after replacing the batteries.

Warning: Lithium batteries can explode or cause burning if they are installed incorrectly. Use only recommended battery brands.

Please note that the installation plate will not attach to the smoke alarm if the batteries are missing or they have been installed incorrectly.

Clean the smoke alarm at least once a year: Separate the smoke alarm from the installation plate by turning it counterclockwise. Separate the smoke alarm carefully (see diagram 2.7 on the opposite page). Test the smoke alarm after cleaning it.

Do not paint or modify the smoke alarm!

Waste handling: The smoke alarm should be disposed in accordance with normal waste handling for electronics.

5. TECHNICAL INFORMATION

Operating principle: Optical
 Voltage: 9 V
 Current consumption: 15 mA
 Sound volume: 85 dB at a distance of 3 meters
 Operating temperature: 0°C – 45 °C
 Maximum humidity: 90%
 Holding temperature of 3M attachment tape -35 °C – 93 °C

6. GUARANTEE

Jalo Helsinki Oy grants a 5-year guarantee, starting from the purchase date of the product. If the smoke alarm becomes defective during the guarantee period, the smoke alarm will be replaced with a new one if the defective one is sent to Jalo Helsinki Oy. The guarantee covers manufacturing or material defects in the product, if the smoke alarm has been used according to the user instructions and the guarantee period has not expired. The guarantee period for a smoke alarm that has been replaced with a new one is the same as that of the original smoke alarm.

The guarantee is not valid if 1) the product is used, maintained, or tested contrary to the user instructions, 2) the defect has been caused by a negligent act by other than Grana Finland Oy or Jalo Helsinki Oy, or 3) if the product has been modified or treated with force, or if it the guarantee receipt is missing. The guarantee does not cover costs due to installation or battery replacement.

Jalo Helsinki Oy's responsibility does not in any case exceed the price of a new smoke alarm. Jalo Helsinki Oy is not responsible for any damage or loss that has been caused by a non-working smoke alarm or negligence by the manufacturer. This guarantee does not affect rights enacted by law.

Manufacturer:
 Jalo Helsinki Oy PL 131, 00181, Helsinki, Finland
www.jalohelsinki.fi, support@jalohelsinki.fi,
www.facebook.com/jalohelsinki

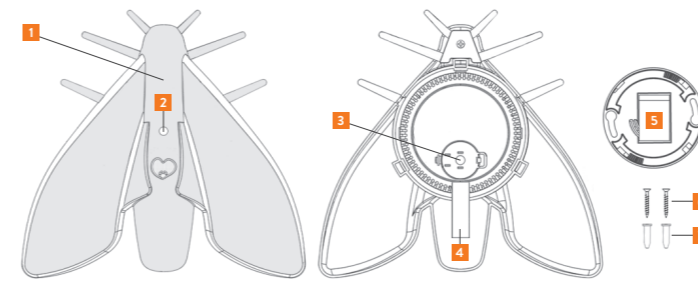

1. Whole-surface test button
2. Signal light
3. Lithium batteries (3)
4. Red battery-protection tapes
5. Two-sided tape for attachment
6. Screws (2)
7. Screw anchors (2)



1. FAST INSTALLATION WITH TWO-SIDED TAPE / LENTO

Make sure that the installation surface is not too rough or dirty for tape. If the ceiling is plastered or rough, install a smoke alarm with the aid of the screws.

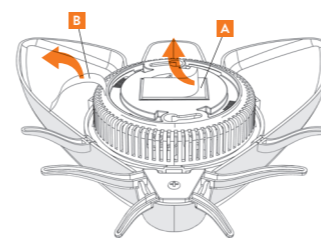

1. Remove the red tape protection (A). Remove the red battery-protection tape (B).
2. Press the smoke alarm firmly against the ceiling for about 30 seconds (C).

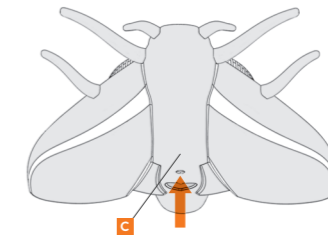

3. Test your smoke alarm by pressing the surface down for three seconds (C). When the smoke alarm gives an alarm sound, the test has been performed successfully. Try it again after 30 minutes to make sure the smoke alarm is attached firmly to the ceiling.

The installation is now ready. Test your smoke alarm weekly!

2. INSTALLATION WITH SCREWS / LENTO

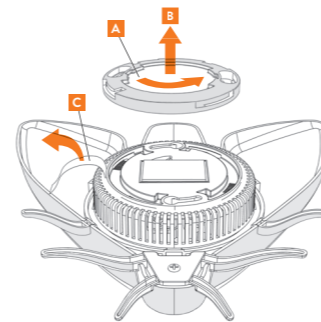

1. Remove the installation plate of the smoke alarm by turning it counterclockwise (A) and lifting it away (B). Pull the red battery-protection tape away (C).

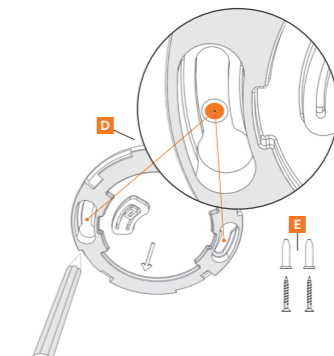

2. Make marks for screw holes (D). You can direct your smoke alarm with the aid of the direction arrow. The direction arrow should point in the same direction as the sides of the smoke alarm.

3. Drill holes for the screw anchors (E) and install the installation plate of the smoke alarm tightly to the ceiling.

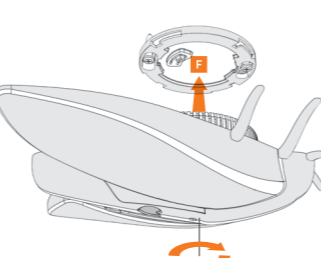

4. Press the smoke alarm against the installation plate (F) and turn it clockwise until you hear four clicks. *Please note that the installation plate will not attach to the smoke alarm if the batteries are missing or they have been installed incorrectly.*

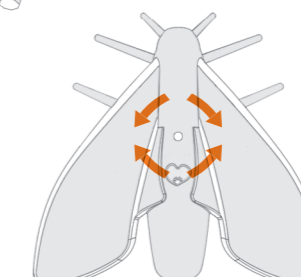

5. You can make small changes in the position of the smoke alarm by turning it a few degrees in the direction you want.

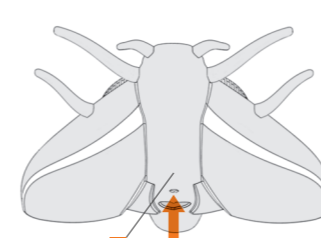

6. Make sure that the smoke alarm is firmly attached to the ceiling. Test your smoke alarm by pressing the surface down for three seconds (G). When the smoke alarm gives an alarm sound, the testing has been performed successfully. *The installation is now ready. Test your smoke alarm weekly!*

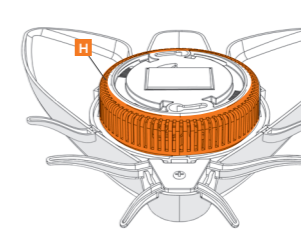

7. (Maintenance) Vacuum the smoke alarm carefully from the grill indicated by the orange area (H).